

ASSESSING THE PERFORMANCE AND CAPACITY OF MATTE LEACHING USING PREDICTIVE MODELS

by F. Crundwell[†] and A. J. Lathwood^{††}

[†]*CM Solutions, P.O. Box 1286, Parklands, 2121*

^{††}*Chief Technical Officer, TWP Matomo Process Plant, P.O. Box 5100, Rivonia, 2128*

A number of base-metal operations would like to increase production to take advantage of the higher metals prices. In general, this higher production should not be achieved with major operating changes. In hydrometallurgical facilities, leaching and pressure leaching represents one area where upfront limitations may be a bottleneck to the capacity of the entire plant. An assessment of the capacity of the leaching tanks and autoclaves was performed using a predictive model within the AweSym flowsheet simulator. The model is described, and the results of the application of the model to a number of different leaching reactors are presented. It is argued that the leaching number, which relates the residence time, particle size and the leaching rate, is of prime importance. Finally it is shown that there are some unexpected catastrophic events in increasing production capacity without a thorough understanding of the leaching operation.

1. Introduction

A result of the sustained increase in metals prices over the last five years has been the expansion of existing operations and the development of new processing facilities. One of the operations in the expansion of hydrometallurgical processes that can limit capacity is the leaching process. On the other hand, leaching reactors are complex. They generally involve three phases; one of these phases changes size on reaction. The design of leaching reactors is relatively unsophisticated. Emphasis is placed on the leaching conditions and chemistry in the design process with little regard for the reactor engineering of this operation.

The lack of a thorough design method has undoubtedly resulted in excessive spending on capital and increased operating costs due to poorer control. For example, it is clear from the data presented for the operation of the zinc pressure-leaching reactor at Trail, British Columbia, that this commercial unit could operate at up to 200% above its design capacity [1,2]. Since the pressure autoclaves contribute as much as 30% to the total capital expenditure for a hydrometallurgy plant, such gross over-estimation of autoclave capacity results in poor economic and engineering decision-making.

The knowledge of the reaction engineering of leaching reactors has improved since the installation of the Trail reactor, and so have the possible methods of design. In this paper, we apply some of these recent developments to the assessment of the performance and capacity of matte leaching autoclaves.

2. Design variables

The factors that need to be accounted for in a thorough design procedure are:

- solids throughput,
- particle size distribution,
- retention time,
- reaction kinetics,
- slurry density,
- lixiviant throughput,
- circuit configuration.

The framework for accounting for all these factors is the population balance model, which accounts for the change in particle size on reaction. It is this change in particle size on reaction that makes the modelling of leaching reactors different to that of other chemical reactors. The principal variable in the population balance model is the leaching number, which is defined in the following expression:

$$N_L = \frac{r_s \bar{t}}{\bar{\ell}} \quad [1]$$

where \bar{t} is the mean residence time, r_s is the rate of shrinkage of the particles (leaching kinetics) and $\bar{\ell}$ is the mean particle size. Equation [1] suggests that in order to achieve a particular conversion in a reactor, there are only three variables that can be manipulated: (i) the residence time, (ii) the particle size, and (iii) the intrinsic leaching rate (through temperature or conversion).

The leaching of matte occurs in two stages. In the reaction an intermediate sulphide product is formed, and in the second, this solid intermediate is leached to completion. For example, consider the leaching of Cu_2S from the matte. The reaction proceeds in the following two steps:

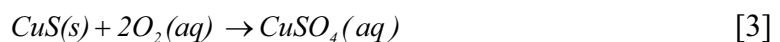
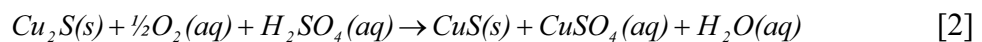

It is the formation of the solid intermediate that makes the reaction kinetics particularly difficult to model. The shrinkage of the core of the Cu_2S and the growth of CuS during the reaction are illustrated in Figure 1.

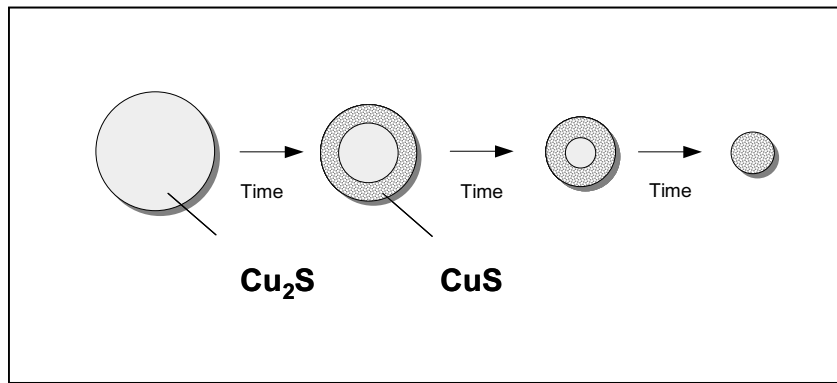
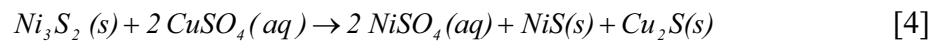

Figure 1: The shrinkage of the Cu_2S and the growth of CuS

The leaching of Ni from the matte takes advantage of the formation of a solid intermediate in order to affect the primary separation between Ni and Cu in the base metal refinery. The first step in the leaching process is the leaching of heazlewoodite, Ni_3S_2 , and the formation of chalcocite, Cu_2S , in the metathesis reaction. This reaction is given as follows:



Thus, both these reactions require special techniques that allow for the description of the shrinkage of the reactant, the formation of the intermediate, and the subsequent reaction of the intermediate. The approach population balance framework was developed and implemented to account for these requirements in this study.

3. Nickel Atmospheric Leaching

The process configuration for the nickel atmospheric leaching section is shown in Figure 2. Matte and spent electrolyte is fed to the first reactor. Oxygen is sparged into the tank. Hofirek and Kerfoot (1992) have described the chemistry of the nickel atmospheric leaching operation. Possible reactions are listed as follows:

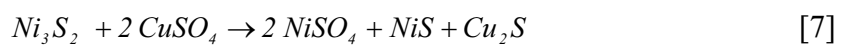
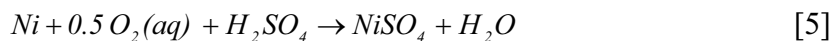

The fourth reaction is the mass transfer of oxygen from the gas phase into the liquid phase. The chemical composition of the final leach product was used to determine the kinetics of each of these reactions, given the mineralogical composition of the feed. This provided a calibration of the model with the operating plant. The kinetics of each of the reactions is given in Table 1.

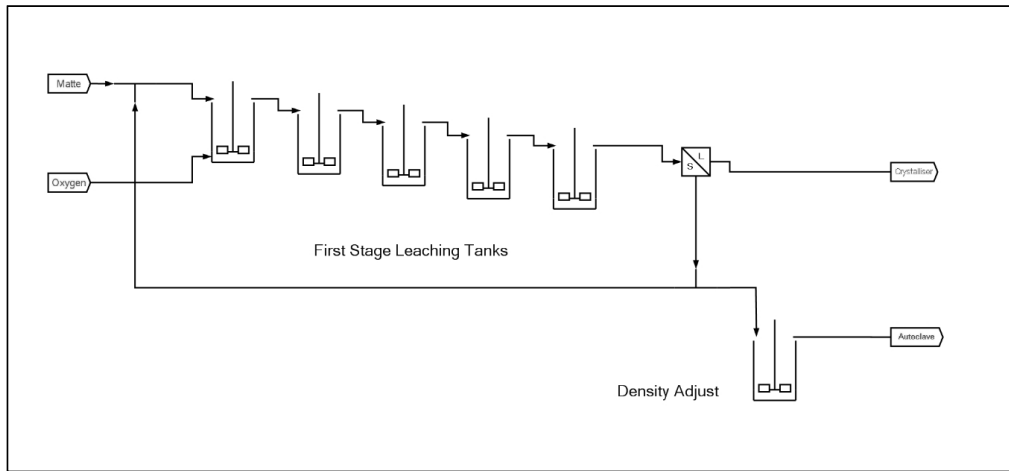

Figure2: Nickel atmospheric leach

Table 1: Kinetics expressions for the nickel atmospheric leach

Reaction	Kinetics
5	$k_s = k_s \dot{e}^{-E_a / RT} [O_2(aq)][H_2SO_4(aq)]^{0.1}$
6	$k_s = k_s \dot{e}^{-E_a / RT} [O_2(aq)][H_2SO_4(aq)]^{0.1}$
7	$k_s = k_s \dot{e}^{-E_a / RT} [CuSO_4(aq)]$
8	$k_L a = 800 hr^{-1}$

The model was used to determine the performance of the nickel atmospheric leach as the plant capacity increased. The results of this simulation are shown in Figure 3 and 4. They indicate that the performance will decline slightly for nickel extraction if the capacity increased to 60 tpd. However, the performance of the copper removal from the solution due to reaction [7] it not affected. Since this is the critical reaction in this process, it is concluded that the nickel atmospheric leaching process does limit or bottleneck the refinery.

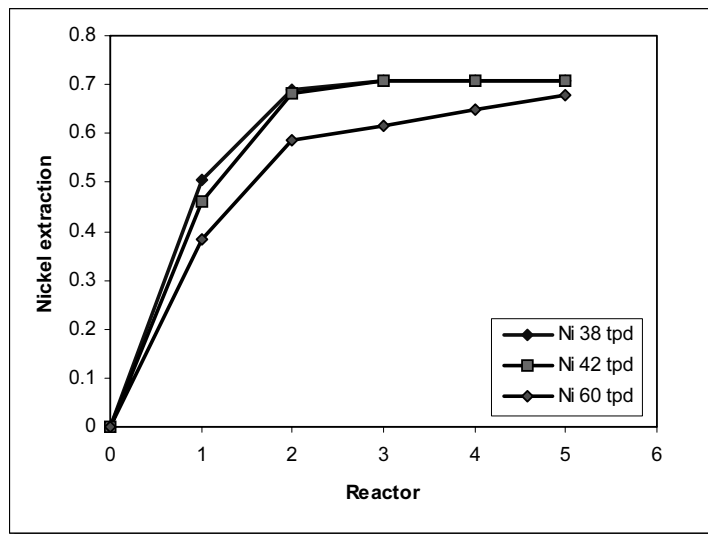

Figure 3. Nickel extraction as a function of capacity.

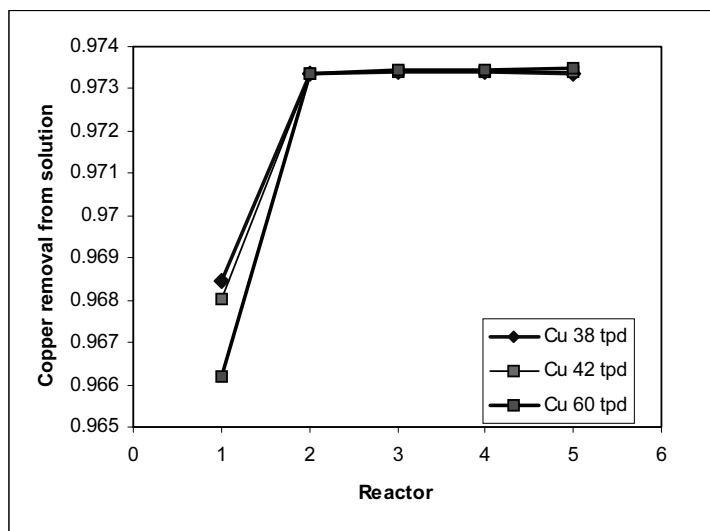

Figure 4. Effect of increases in capacity on the copper removal from solution.

4. Second stage autoclave

The configuration of the autoclave is shown in Figure 5. The feed consisting of nickel atmospheric leach product and spent electrolyte is adjusted for acid and density. The product of this mixing operation is fed to the autoclave feed tank and is mixed with the liquid product from the autoclave flash drum. This material is fed to the first compartment of a four compartment autoclave. The first compartment is three times the size of the other compartments. Material flows from the first compartment to the third, where it is removed from the autoclave and filtered. The solids are fed to the mixed

tank for density adjustment, and into the fourth compartment. This last compartment represents the third stage leaching process.

Hofirek and Kerfoot (1992) investigated the chemistry of the Second Stage Leaching operation. The reactions that they suggested are listed as follows:

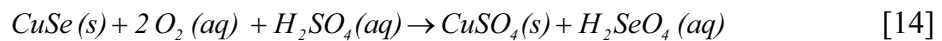
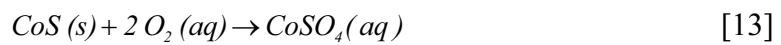
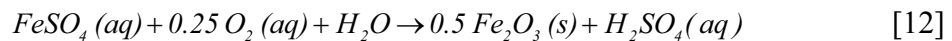
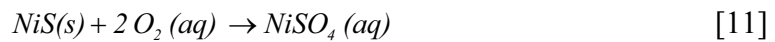
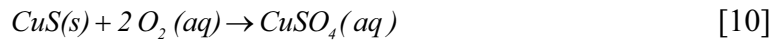
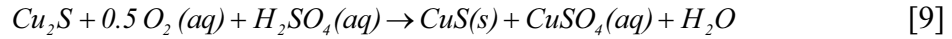

The parameters for the kinetic expressions were determined by fitting the final residue concentrations. The values determined from this exercise are given in Table 2.

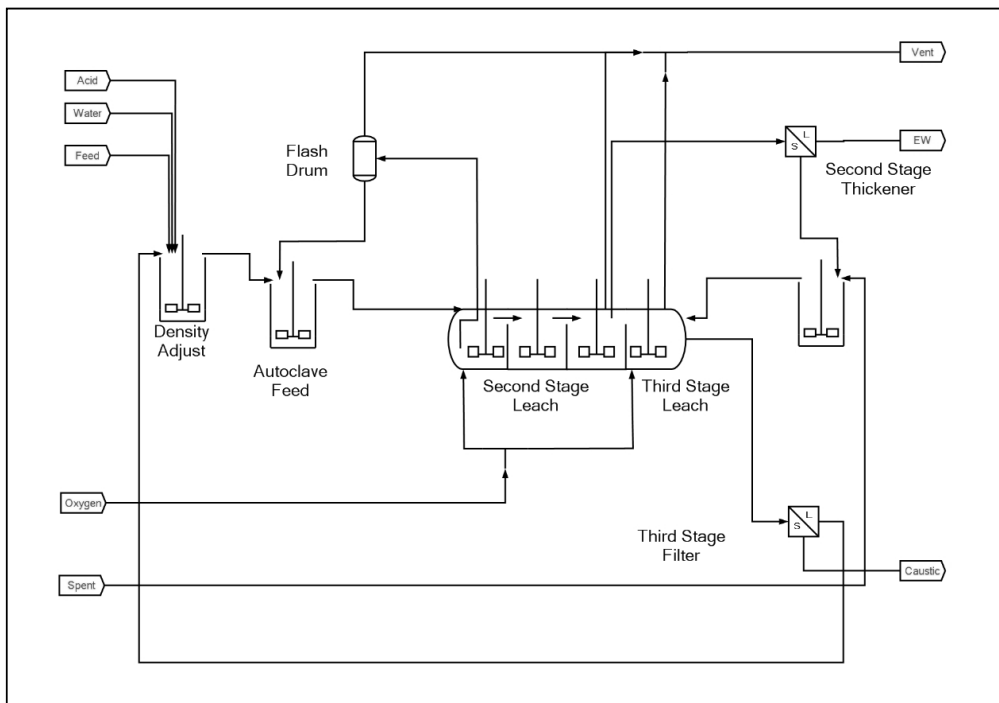

Figure 5: Second and third stage autoclave configuration.

Table 2: Kinetics for the reactions occurring in the autoclave.

Reaction	Rate
9	$k_s = k'_s e^{-E_a/RT} [O_2(aq)](1. - [CuSO_4(aq)]/4.7)$
10	$k_s = k'_s e^{-E_a/RT} [O_2(aq)](1. - [CuSO_4(aq)]/4.7)$
11	$k_s = k'_s e^{-E_a/RT} [O_2(aq)]$
12	$ext = 0.689$
13	$ext = 0.689$
14	$ext = 0.631$
15	$ext = 0.631$
16	$k_L a = 1800hr^{-1}$

The capacity of a leaching reactor is a function of the residence time, the reaction kinetics, gas-liquid mass transfer rates, and heat transfer. The conversion that can be achieved in the reactor, assuming that there is no limitation due to either gas-liquid mass transfer or energy removal, is shown in Figure 6. The design basis for the operation is that the copper extraction should be between 92 and 95% and that the nickel extraction should be between 93 and 95%. The results shown in Figure 6 suggest that each autoclave should be able to process up to a matte equivalent of 30 tpd.

The three main reactions that occur in the autoclave are given as Equations 9, 10 and 11. Of these three reactions, the first, which occurs rapidly, generates the least heat due to reaction. The amount of heat transfer required in each stage changes as the feed rate of into the reactor increases is shown in Figure 7.

The results shown in Figure 7 indicates that the amount of energy that is generated, and hence the heat that must be removed from the autoclave, increases significantly as the amount of material fed to the autoclave increases. It is very significant that the proportion of the heat generated in each compartment changes as the autoclave processes more material, a result of the cooling achieved by more water flow, the lowering of the conversion in the first compartment and the increase in the conversion of the subsequent compartments. This feature can have a significant bearing on the capacity of the autoclave, since heat removal (through the flash mechanism) is primarily from the first compartment. Thus the cooling mechanism in the second and third compartments represents possible limitations to capacity.

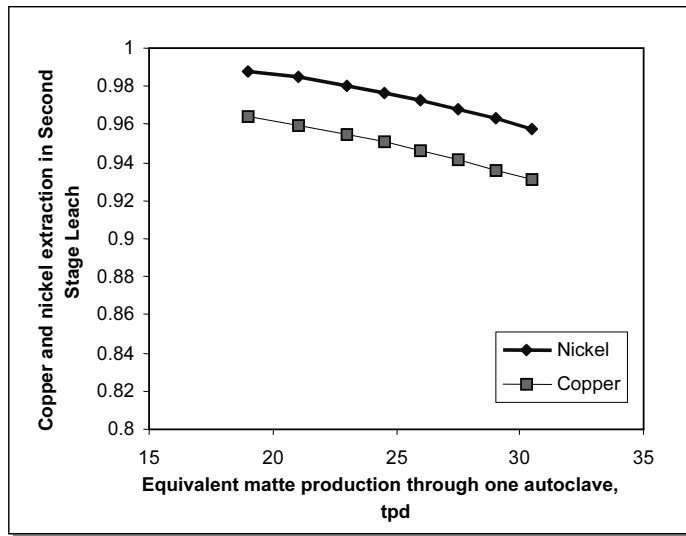

Figure 6: The copper and nickel extractions in the Second Stage leach assuming no limitations due to gas-liquid mass transfer or heat transfer.

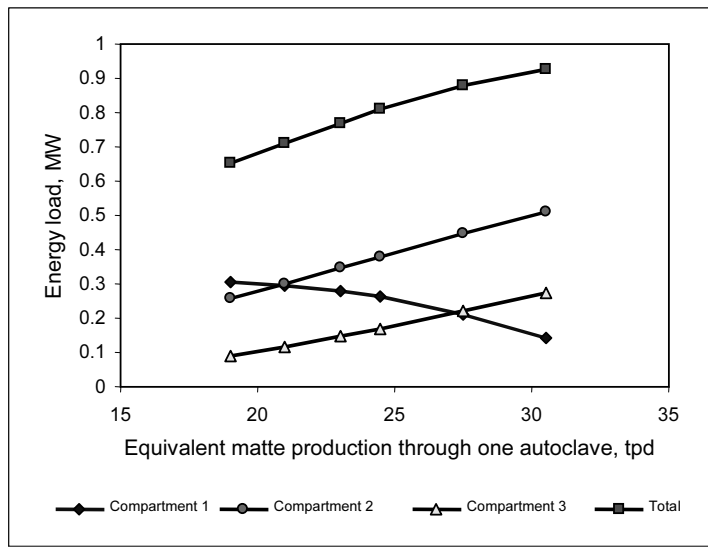

Figure 7: The energy load for heat removal from the Second Stage leach as a function of the amount of material processed in the reactor.

5. Third stage leach

The third stage leach is the same as the second stage leach, except that it is conducted with much lower solids density and the copper tenor in solution is much lower. As a result, this process is highly efficient. This stage does not represent a limitation to the capacity of the operation.

6. Discussion

An interesting feature of leaching reactors is the catastrophic failure of the reactor due to a decrease of the mass transfer coefficient. This can also occur if the rate consumption of the available oxygen is greater than the rate of mass transfer. Figure 8 shows the catastrophic failure of a leaching reactor due to the decrease in the mass transfer coefficient, a result of changes in, say, the agitation speed. Figure 9 shows the catastrophic failure of the reactor as a result of increasing the leaching load to the reactor (in this case at a sulphide grade of 30%). Either of these factors, amongst others, could limit the capacity of a leaching reactor. The results of this study indicated that this does not occur under the set of conditions chosen to represent normal operation. However, when production is being pushed, and a number of changes are made at once, it is much easier to push the autoclave or the leach “out of balance.”

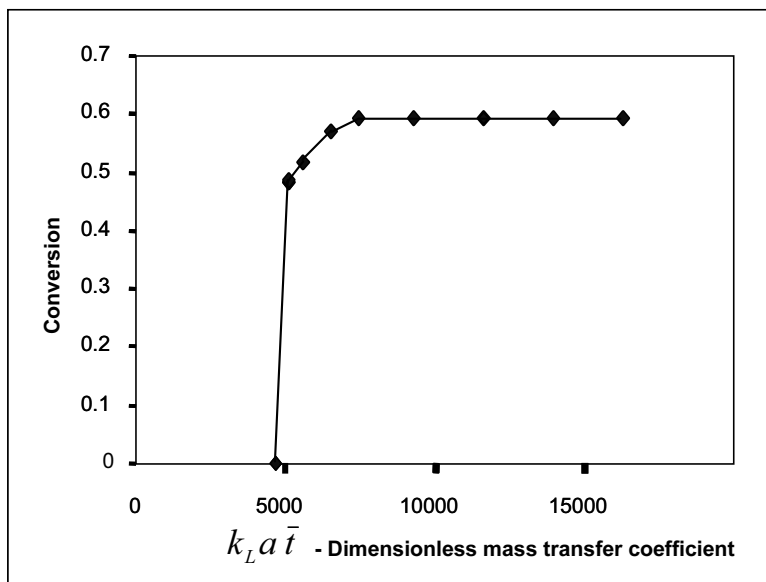

Figure 8: The effect of the mass transfer coefficient on the performance of a leaching reactor.

7. Conclusions

This paper has reported the results of a study of the capacity of an operation by developing a model of the system. The results show that although the performance may drop slightly as a result of increased throughput, there is significant room for increases in capacity. Since the mass transfer coefficient is a critical parameter in this regard, these results are subject to further clarify of the mass transfer conditions.

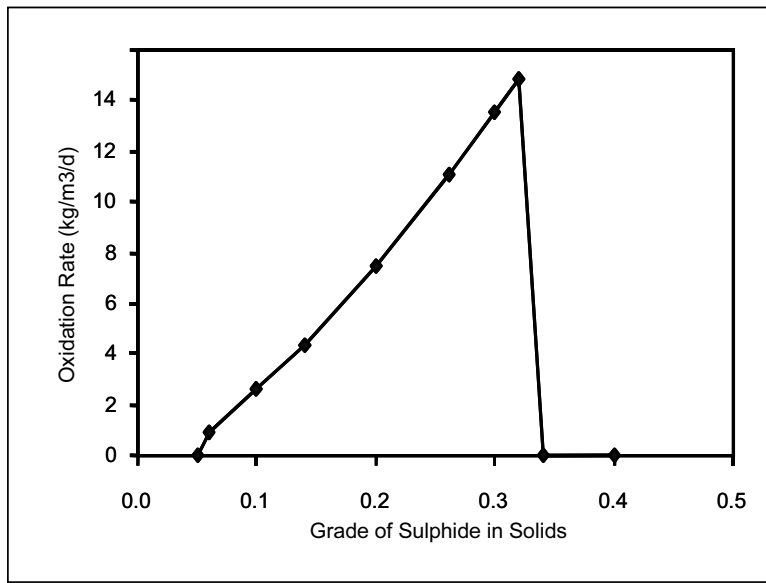

Figure 9: The effect of increasing the sulphide load on the performance of a leaching reactor.